



# HP ZR30w LCD Monitor

User Guide

© 2009 Hewlett-Packard Development  
Company, L.P.

Microsoft, Windows, and Windows Vista are either trademarks or registered trademarks of Microsoft Corporation in the United States and/or other countries.

The only warranties for HP products and services are set forth in the express warranty statements accompanying such products and services . Nothing herein should be construed as constituting an additional warranty. HP shall not be liable for technical or editorial errors or omissions contained herein.



This document contains proprietary information that is protected by copyright. No part of this document may be photocopied, reproduced, or translated to another language without the prior written consent of Hewlett-Packard Company.

First Edition (December 2009)

Document Part Number: 595125-001

## About This Guide

This guide provides information on setting up the monitor, installing drivers, using the on-screen display menu, troubleshooting and technical specifications.

-  **WARNING!** Text set off in this manner indicates that failure to follow directions could result in bodily harm or loss of life.
-  **CAUTION:** Text set off in this manner indicates that failure to follow directions could result in damage to equipment or loss of information.
-  **NOTE:** Text set off in this manner provides important supplemental information.



---

# Table of contents

## 1 Product Features

HP ZR30w Model .....	1
----------------------	---

## 2 Safety and Maintenance Guidelines

Important Safety Information .....	2
Maintenance Guidelines .....	3
Cleaning the Monitor .....	3
Shipping the Monitor .....	3

## 3 Setting Up the Monitor

Installing the Monitor Pedestal Base .....	4
Rear Components .....	5
HP ZR30w Model .....	5
Routing and Connecting the Cables .....	6
Connecting USB Devices .....	8
Adjusting the Monitor .....	8
Turning on the Monitor .....	10
Removing the Monitor Pedestal Base .....	11
Mounting the Monitor .....	12
Locating the Rating Labels .....	14
Installing an HP/Kensington MicroSaver Security Cable Lock .....	14

## 4 Operating the Monitor

Software and Utilities .....	15
The Information File .....	15
The Image Color Matching File .....	15
Installing the .INF and .ICM Files .....	16
Installing from the CD .....	16
Downloading from the Worldwide Web .....	16
Front Panel Controls .....	17
Dynamic Contrast Ratio (DCR) .....	18

## Appendix A Troubleshooting

Solving Common Problems .....	19
Online Technical Support .....	20
Preparing to Call Technical Support .....	20

## Appendix B Technical Specifications

ZR30w Model .....	21
Energy Saver Feature .....	22

## Appendix C Agency Regulatory Notices

Federal Communications Commission Notice .....	23
Modifications .....	23
Cables .....	23
Declaration of Conformity for Products Marked with the FCC Logo (United States Only) .....	23
Canadian Notice .....	24
Avis Canadien .....	24
European Union Regulatory Notice .....	24
German Ergonomics Notice .....	25
Japanese Notice .....	25
Korean Notice .....	25
Power Cord Set Requirements .....	25
Japanese Power Cord Requirements .....	26
Product Environmental Notices .....	26
Materials Disposal .....	26
Disposal of Waste Equipment by Users in Private Household in the European Union .....	26
HP Recycling Program .....	26
Chemical Substances .....	26
Restriction of Hazardous Substances (RoHS) .....	26
Turkey EEE Regulation .....	27

## Appendix D LCD Monitor Quality and Pixel Policy

---

# 1 Product Features

## HP ZR30w Model

The LCD (liquid crystal display) monitor has an active matrix, thin-film transistor (TFT) panel. The monitor features include:

- 29.7-inch (75.4 cm) viewable area display with 2560 x 1600 resolution
- Wide viewing angle to allow viewing from a sitting or standing position, or moving side-to-side
- Tilt, swivel, and height adjustment capabilities
- Removable stand for flexible mounting solutions with HP Quick Release and VESA 100 mm mounting holes
- Video signal input to support DVI digital with DVI-D signal cable provided
- Video signal input to support DisplayPort digital with DisplayPort signal cable provided
- USB 2.0 hub with one upstream (connects to the computer) and four downstream (connects to USB devices) ports
- USB cable provided to connect the monitor's USB hub to the USB connector on the computer
- Supports the optional HP speaker bar (purchased separately)
- Plug and play capability if supported by the system
- Security slot provision on rear of monitor for optional cable lock
- Cable management feature for placement of cables and cords
- HDCP (High-Bandwidth Digital Content Protection) copy protection on DVI and DisplayPort inputs
- Software and documentation CD that includes monitor drivers and product documentation
- Energy saver feature to meet requirements for reduced power consumption
- EDID support for Asset Management
- Compliant with the following regulated specifications:
  - European Union CE Directives
  - Swedish MPR II 1990

---

## 2 Safety and Maintenance Guidelines

### Important Safety Information

A power cord is included with the monitor. If another cord is used, use only a power source and connection appropriate for this monitor. For information on the correct power cord set to use with the monitor, refer to the [Power Cord Set Requirements on page 25](#) in Appendix C.

---

⚠ **WARNING!** To reduce the risk of electric shock or damage to the equipment:

- Do not disable the power cord grounding feature. The grounding plug is an important safety feature.
- Plug the power cord in a grounded (earthed) outlet that is easily accessible at all times.
- Disconnect power from the product by unplugging the power cord from the electrical outlet.

For your safety, do not place anything on power cords or cables. Arrange them so that no one may accidentally step on or trip over them. Do not pull on a cord or cable. When unplugging from the electrical outlet, grasp the cord by the plug.

To reduce the risk of serious injury, read the *Safety and Comfort Guide*. It describes proper workstation, setup, posture, and health and work habits for computer users, and provides important electrical and mechanical safety information. This guide is located on the Web at <http://www.hp.com/ergo> and/or on the documentation CD, if one is included with the monitor.

⚠ **CAUTION:** For the protection of the monitor, as well as the computer, connect all power cords for the computer and its peripheral devices (such as a monitor, printer, scanner) to some form of surge protection device such as a power strip or Uninterruptible Power Supply (UPS). Not all power strips provide surge protection; the power strips must be specifically labeled as having this ability. Use a power strip whose manufacturer offers a Damage Replacement Policy so you can replace the equipment, if surge protection fails.

---

Use the appropriate and correctly sized furniture designed to properly support your HP LCD monitor.

⚠ **WARNING!** LCD monitors that are inappropriately situated on dressers, bookcases, shelves, desks, speakers, chests, or carts may fall over and cause personal injury.

Care should be taken to route all cords and cables connected to the LCD monitor so that they can not be pulled, grabbed, or tripped over.

---



# Maintenance Guidelines

To enhance the performance and extend the life of the monitor:

- Do not open the monitor cabinet or attempt to service this product yourself. Adjust only those controls that are covered in the operating instructions. If the monitor is not operating properly or has been dropped or damaged, contact an authorized HP dealer, reseller, or service provider.
- Use only a power source and connection appropriate for this monitor, as indicated on the label/back plate of the monitor.
- Be sure the total ampere rating of the products connected to the outlet does not exceed the current rating of the electrical outlet, and the total ampere rating of the products connected to the cord does not exceed the rating of the cord. Look on the power label to determine the ampere rating (AMPS or A) for each device.
- Install the monitor near an outlet that you can easily reach. Disconnect the monitor by grasping the plug firmly and pulling it from the outlet. Never disconnect the monitor by pulling the cord.
- Turn the monitor off when not in use. You can substantially increase the life expectancy of the monitor by using a screen saver program and turning off the monitor when not in use.

---

 **NOTE:** Monitors with a “burned-in image” are not covered under the HP warranty.

---

- Slots and openings in the cabinet are provided for ventilation. These openings must not be blocked or covered. Never push objects of any kind into cabinet slots or other openings.
- Do not drop the monitor or place it on an unstable surface.
- Do not allow anything to rest on the power cord. Do not walk on the cord.
- Keep the monitor in a well-ventilated area, away from excessive light, heat or moisture.
- When removing the monitor stand, you must lay the monitor face down on a soft area to prevent it from getting scratched, defaced, or broken.

## Cleaning the Monitor

1. Turn off the monitor and unplug the power cord from the back of the unit.
2. Dust the monitor by wiping the screen and the cabinet with a soft, clean antistatic cloth.
3. For more difficult cleaning situations, use a 50/50 mix of water and Isopropyl alcohol.

△ **CAUTION:** Spray the cleaner onto a cloth and use the damp cloth to gently wipe the screen surface. Never spray the cleaner directly on the screen surface. It may run behind the bezel and damage the electronics.

**CAUTION:** Do not use cleaners that contain any petroleum based materials such as benzene, thinner, or any volatile substance to clean the monitor screen or cabinet. These chemicals may damage the monitor.

---

## Shipping the Monitor

Keep the original packing box in a storage area. You may need it later if you move or ship the monitor.

---

## 3 Setting Up the Monitor

To set up the monitor, ensure that the power is turned off to the monitor, computer system, and other attached devices, then follow the instructions below.

 **NOTE:** Be sure the master power switch, located on the rear panel of the monitor, is in the off position. The master power switch turns off all power to the monitor.

---

### Installing the Monitor Pedestal Base

 **NOTE:** Do not install the pedestal base if the monitor will be used on a wall, swing arm, or other mounting fixture; instead see [Mounting the Monitor on page 12](#) in this chapter.

---

1. Using both hands, position the monitor over the pedestal base.

 **CAUTION:** Do not touch the surface of the LCD panel. Pressure on the panel may cause non-uniformity of color or disorientation of the liquid crystals. If this occurs the screen will not recover to its normal condition.

---

2. Press down firmly on the monitor to lock the pedestal base in place. When the base locks, it will make a clicking sound.

**Figure 3-1** Inserting the Monitor into the Pedestal Base



 **NOTE:** Be sure the pedestal base is securely locked before continuing with the setup.

---

# Rear Components

## HP ZR30w Model

Figure 3-2 Rear Components

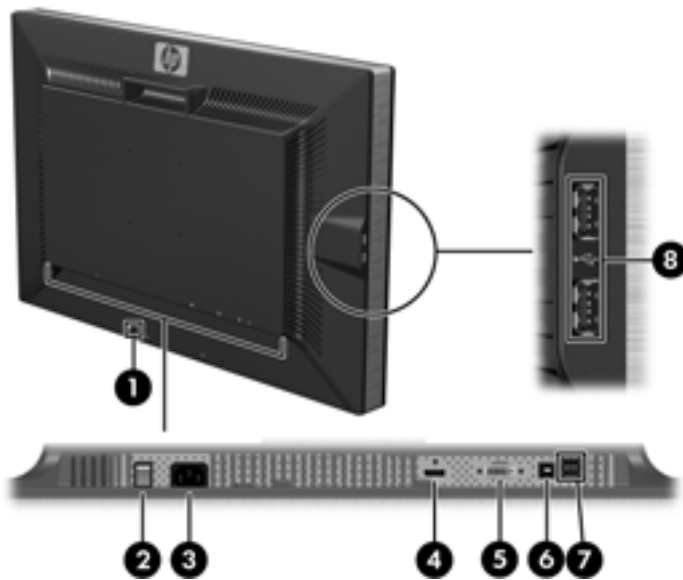

Table 3-1 Rear Components

Component	Function
1 Cable Lock Provision	Provides slot for use with cable security locks.
2 Master Power Switch	Turns off all power to the monitor.
3 AC Power Connector	Connects the AC power cord to the monitor.
4 DisplayPort Connector	Connects the DisplayPort cable to the monitor.
5 DVI-D Connector	Connects the DVI-D cable to the monitor.
6 USB Upstream Connector	Connects the monitor USB hub cable to a host USB port/hub.
7 USB Downstream Connectors	Connects optional USB devices to the monitor.
8 USB Downstream Connectors (side panel)	Connects optional USB devices to the monitor.

## Routing and Connecting the Cables

1. Place the monitor in a convenient, well-ventilated location near the computer.
2. Remove the cable routing cover by pulling it straight off the front of the column.

**Figure 3-3** Removing the Cable Routing Cover



3. Before connecting the cables, route them through the cable routing hole in the column (1) and replace the cable routing cover (2).

**Figure 3-4** Routing Cables

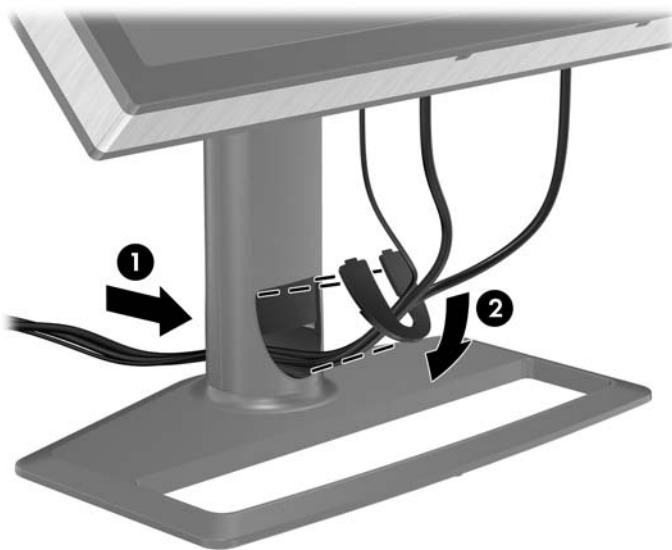



4. Connect a DVI-D signal cable or DisplayPort signal cable.

 **NOTE:** The video source is determined by the video cable used. The monitor will automatically determine which inputs have valid video signals. The inputs can be selected by pressing the Source button on the front panel .

- For DVI digital operation, use the DVI-D signal cable provided. Connect the DVI-D signal cable to the DVI connector on the rear of the monitor and the other end to the DVI connector on the computer.
  - For DisplayPort digital operation, use the DisplayPort signal cable provided. Connect the DisplayPort signal cable to the DisplayPort connector on the rear of the monitor and the other end to the DisplayPort connector on the computer.
5. Connect one end of the provided USB cable to the USB hub connector on the rear panel of the computer, and the other end to the upstream USB connector on the monitor.
  6. Connect one end of the power cable to the AC power connector on the back of the monitor, and the other end to an electrical wall outlet.

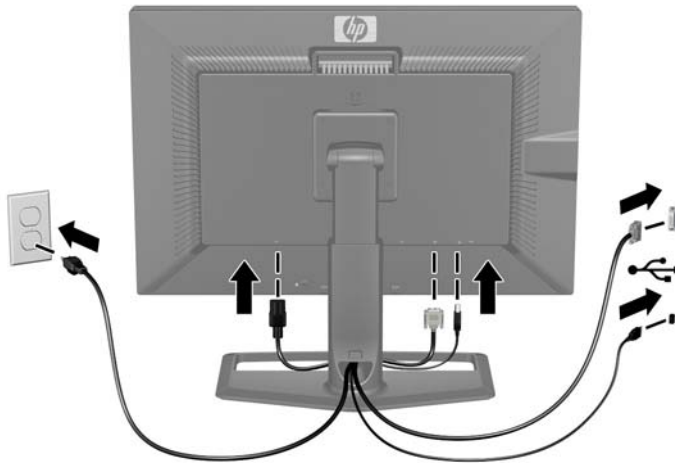
**Figure 3-5** Connecting the Cables



 **WARNING!** To reduce the risk of electric shock or damage to the equipment:

Do not disable the power cord grounding plug. The grounding plug is an important safety feature.

Plug the power cord into a grounded (earthed) electrical outlet that is easily accessible at all times.

Disconnect power from the equipment by unplugging the power cord from the electrical outlet.

For your safety, do not place anything on power cords or cables. Arrange them so that no one may accidentally step on or trip over them. Do not pull on a cord or cable. When unplugging from the electrical outlet, grasp the cord by the plug.

## Connecting USB Devices

The monitor provides USB connectors on the side panel and on the rear panel that can be used to connect devices such as a digital camera, USB keyboard, or USB mouse.

 **NOTE:** You must connect the USB hub cable from the monitor to the computer to enable the USB 2.0 ports on the monitor. Refer to Step 5 in [Routing and Connecting the Cables on page 6](#).

**Figure 3-6** Connecting USB Devices

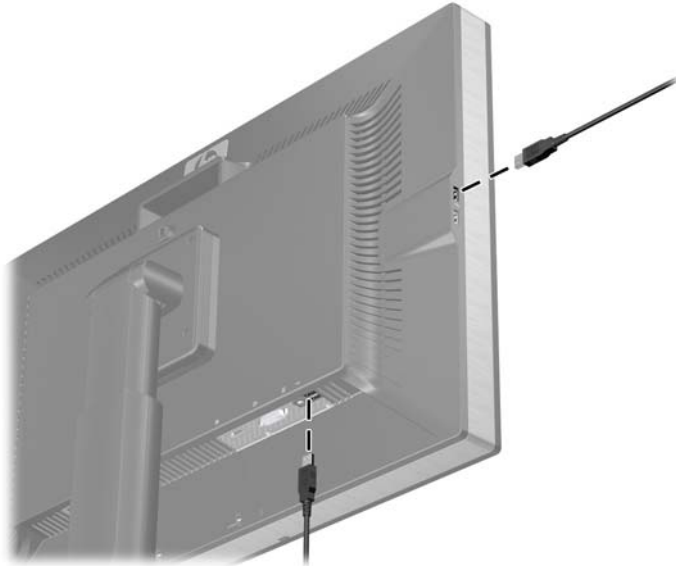

## Adjusting the Monitor

1. Tilt the monitor's panel forward or backward to set it to a comfortable eye level.

**Figure 3-7** Tilting the Monitor



2. Swivel the monitor to the left or right for the best viewing angle.

**Figure 3-8** Swiveling the Monitor



3. Adjust the monitor's height so that it is parallel to your eye height for a comfortable viewing position. A lock-down/release button on the back of the column prevents the display head from sliding up when the monitor is lifted. If the display head is locked in the lowest height position:
  - a. Make sure that the monitor is safely positioned on a stable surface.
  - b. Gently push down on the display head (1).
  - c. While pushing down the display head, press the lock-down/release button on the back of the column (2).
  - d. Guide the display head up to the desired height (3).

**Figure 3-9** Adjusting the Height

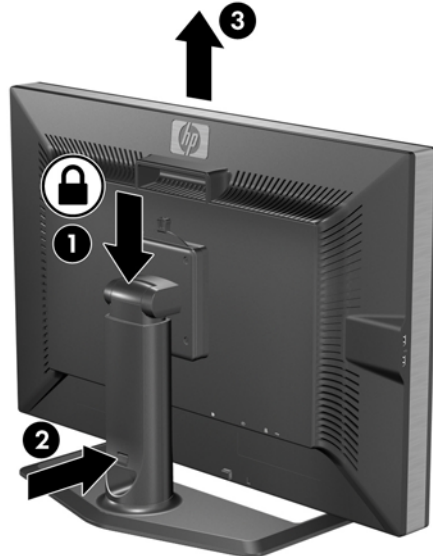

## Turning on the Monitor

1. Ensure that the master power switch on the rear of the monitor is in the On position.
2. Press the power button on the computer to turn it on.
3. Press the power button on the front of the monitor to turn it on.

---

△ **CAUTION:** Burn-in image damage may occur on monitors that display the same static image on screen for a prolonged period of time.\* To avoid burn-in image damage on the monitor screen, you should always activate a screen saver application or turn off the monitor when it is not in use for a prolonged period of time. Image retention is a condition that may occur on all LCD screens. Monitors with a “burned-in image” are not covered under the HP warranty.

\* A prolonged period of time is 12 consecutive hours of non-use.

---

The monitor automatically scans the signal inputs for an active input and uses that input for the display. If two inputs are active, the monitor will display the default input source. If the default source is not one of the active inputs, then the monitor will display the highest ranking priority input in the following order: DisplayPort, then DVI. You can change the default source by pressing the Source button on the front panel.



## Removing the Monitor Pedestal Base

You can remove the monitor panel from the pedestal base to mount the panel on a wall, a swing arm, or other mounting fixture (purchased separately).

This monitor has a Quick Release mechanism that allows you to easily remove and replace the monitor panel to the pedestal base.

△ **CAUTION:** Before beginning to disassemble the monitor, be sure the monitor is turned off and the power and signal cables are both disconnected. Also disconnect any USB cables that are connected to the monitor.

1. Disconnect the signal, power, and USB cables from the back of the monitor.
2. Slide the Quick Release latch (1) on the pedestal base to the side (either right or left).
3. Pull up on the monitor display head (2) to remove it from the base.

**Figure 3-10** Removing the Monitor from the Pedestal Base

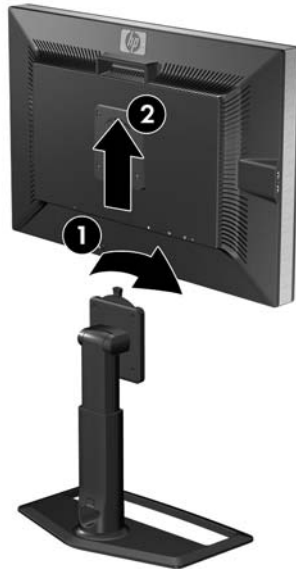

## Mounting the Monitor

 **NOTE:** This apparatus is intended to be supported by UL or CSA Listed wall mount bracket.

The HP Quick Release can be removed from the pedestal base and installed to a mounting fixture. It allows you to quickly and securely attach the monitor panel to the mounting fixture.

1. Remove the monitor panel from the pedestal base. Refer to [Removing the Monitor Pedestal Base on page 11](#) in the previous section.

△ **CAUTION:** This monitor supports the VESA industry standard 100 mm mounting holes. To attach a third-party mounting solution to the monitor, four 4 mm, 0.7 pitch, and 10 mm long screws are required (not provided with the monitor). Longer screws must not be used because they may damage the monitor. It is important to verify that the manufacturer's mounting solution is compliant with the VESA standard and is rated to support the weight of the monitor display panel. For best performance, it is important to use the power and video cables provided with the monitor.

2. Remove the Quick Release from the pedestal base by removing the four screws.

**Figure 3-11** Removing the HP Quick Release from the Pedestal Base

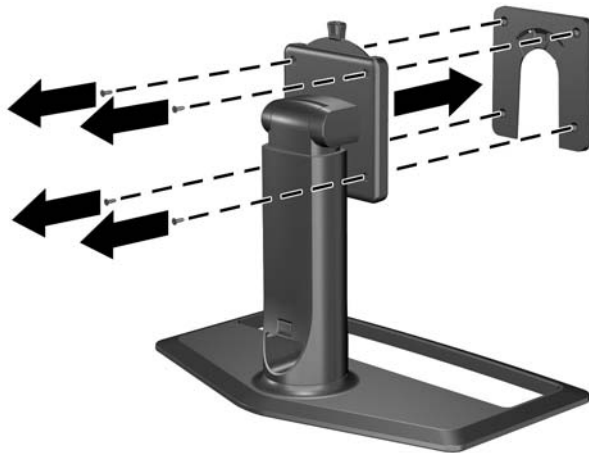

3. Mount the Quick Release to a swing arm or other mounting fixture using the four screws removed from the Quick Release in the previous step.

**Figure 3-12** Installing the Quick Release

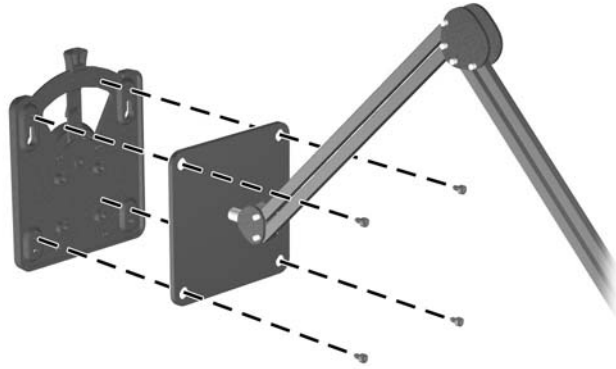

△ **CAUTION:** The Quick Release can also be installed directly to a wall to mount the monitor panel. It is designed to support a maximum of up to 10.9 kg (24 lbs). If you are mounting to a wall, HP recommends that you consult with a qualified engineering, architectural, or construction professional to determine the appropriate type and quantity of mounting fasteners required for your application and to ensure that the mounting solution is properly installed to support applied loads.

4. Insert the monitor panel into the Quick Release, and then press down firmly on the monitor to lock it in place. When the Quick Release locks, it will make a clicking sound.

**Figure 3-13** Inserting the Monitor Panel into the Quick Release



## Locating the Rating Labels

The rating labels on the monitor provide the spare part number, product number, and serial number. You may need these numbers when contacting HP about the monitor model. The rating labels are located on the rear panel of the monitor display head.

**Figure 3-14** Locating the Rating Labels

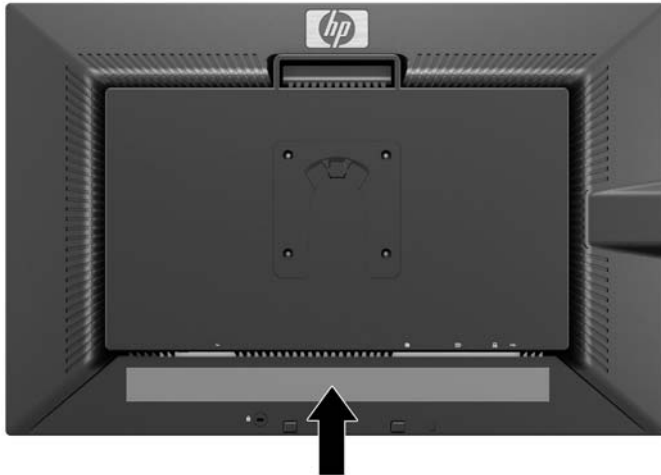

## Installing an HP/Kensington MicroSaver Security Cable Lock

You can secure the monitor to a fixed object with an optional cable lock available from HP.

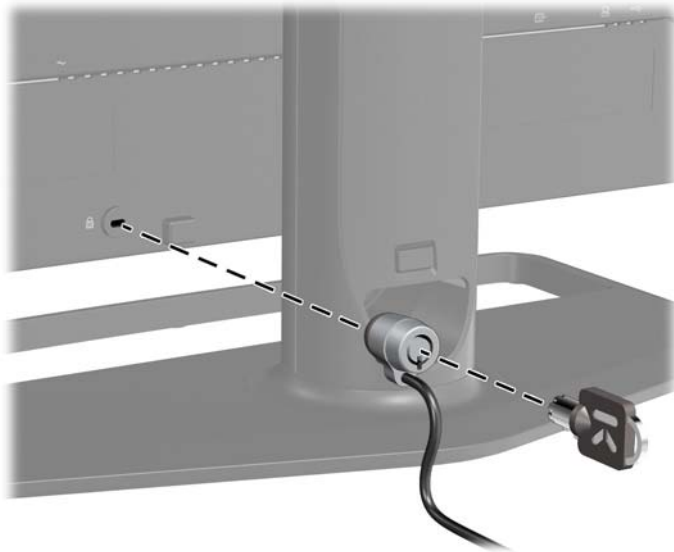

---

# 4 Operating the Monitor

## Software and Utilities

The CD that comes with the monitor contains files you can install on the computer:

- an .INF (Information) file
- an .ICM (Image Color Matching) file
- additional software for the monitor model

 **NOTE:** If the monitor does not include a CD, the .INF and .ICM files can be downloaded from the HP monitors support Web site. See [Downloading from the Worldwide Web on page 16](#) in this chapter.

### The Information File

The .INF file defines monitor resources used by Microsoft Windows operating systems to ensure monitor compatibility with the computer's graphics adapter.

This monitor is Microsoft Windows Plug and Play compatible and the monitor will work correctly without installing the .INF file. Monitor Plug and Play compatibility requires that the computer's graphic card is VESA DDC2-compliant and that the monitor connects directly to the graphics card. Plug and Play does not work through separate BNC type connectors or through distribution buffers/boxes.

### The Image Color Matching File

The .ICM files are data files that are used in conjunction with graphics programs to provide consistent color matching from monitor screen to printer, or from scanner to monitor screen. The .ICM file contains a monitor color system profile. This file is activated from within graphics programs that support this feature.

 **NOTE:** The ICM color profile is written in accordance with the International Color Consortium (ICC) Profile Format specification.

## Installing the .INF and .ICM Files

After you determine that you need to update, you can install the .INF and .ICM files from the CD or download them.

### Installing from the CD

To install the .INF and .ICM files on the computer from the CD:

1. Insert the CD in the computer CD-ROM drive. The CD menu is displayed.
2. View the **Monitor Driver Software Readme** file.
3. Select **Install Monitor Driver Software**.
4. Follow the on-screen instructions.
5. Ensure that the proper resolution and refresh rates appear in the Windows Display control panel.

 **NOTE:** You may need to install the digitally signed monitor .INF and .ICM files manually from the CD in the event of an installation error. Refer to the Monitor Driver Software Readme file on the CD.

### Downloading from the Worldwide Web

To download the latest version of .INF and .ICM files from the HP monitors support Web site:

1. Refer to <http://www.hp.com/support> and select the country region.
2. Follow the links for the monitor to the support page and download page.
3. Ensure the system meets the requirements.
4. Download the software by following the instructions.

# Front Panel Controls

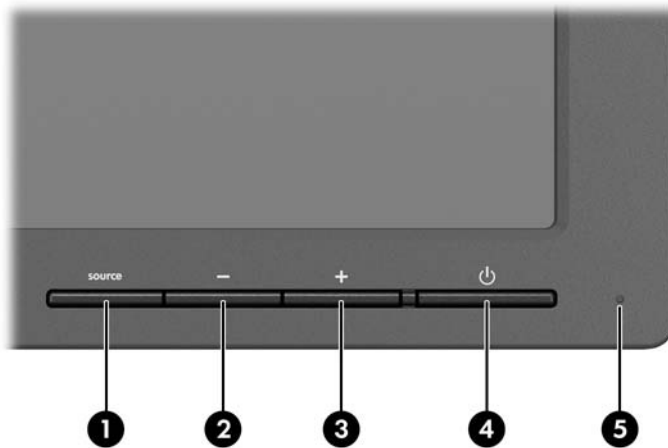

**Table 4-1** Monitor Front Panel Controls

Control	Function
1 Source	Selects the video input (DisplayPort or DVI-D)
2 – (Minus)	Reduces the brightness setting.
3 + (Plus)	Increases the brightness setting.
<b>NOTE:</b> Pressing the + (Plus) and – (Minus) buttons at the same time enables or disables the Dynamic Contrast Ratio (DCR) function. When enabling the DCR function, the power LED will flash four times. When disabling the DCR function, the power LED will flash one time.	
4 Power	Turns the monitor on or off.
5 Power LED	Sleep mode — amber Continuous flashing blue — non-supported video mode Three flashes of blue — upper or lower limit of brightness control Four flashes of blue — DCR is enabled One flash of blue — DCR is disabled Steady blue — full power and monitor is displaying a supported mode (LED automatically turns off after 30 seconds)

 **NOTE:** The monitor does not support an On-Screen Display (OSD) menu.

## Dynamic Contrast Ratio (DCR)

Contrast ratio is the ratio between the brightest white and the darkest black produced by a monitor display. DCR increases contrast ratio by automatically adjusting the backlight based on image content. The higher contrast ratio is achieved dynamically over several frames.

---

 **NOTE:** DCR should only be enabled when viewing video full screen.

---

The default setting for DCR is disabled. To enable DCR, press the + (Plus) and – (Minus) buttons on the front panel at the same time. The power LED will flash four times. To disable DCR, press the + (Plus) and – (Minus) buttons on the front panel again. The power LED will flash one time.



---

# A Troubleshooting

## Solving Common Problems

The following table lists possible problems, the possible cause of each problem, and the recommended solutions.

<b>Problem</b>	<b>Possible Cause</b>	<b>Solution</b>
Screen is blank and no LED.	Power cord is disconnected.	Connect the power cord.
	Master power switch is turned off.	Set the master power switch on the rear panel of the monitor to the On position and press the front panel power button.
	Power button on front panel of the monitor is turned off.	Press the front panel power button.
	Video cable is improperly connected.	Connect the video cable properly. Refer to <a href="#">Setting Up the Monitor on page 4</a> for more information.
	Screen blanking is active.	Press any key on the keyboard or move the mouse to inactivate the screen blanking utility.
Brightness is too high or low.	Brightness adjustment is not set correctly.	Adjust the brightness setting using the – (Minus) and + (Plus) buttons.

## Online Technical Support

For the online access to technical support information, self-solve tools, online assistance, community forums of IT experts, broad multivendor knowledge base, monitoring and diagnostic tools, go to <http://www.hp.com/support>.

## Preparing to Call Technical Support

If you cannot solve a problem using the troubleshooting tips in this section, you may need to call technical support. Have the following information available when you call:

- Monitor model number
- Monitor serial number
- Purchase date on invoice
- Conditions under which the problem occurred
- Error messages received
- Hardware configuration
- Name and version of the hardware and software you are using

## B Technical Specifications

 **NOTE:** All performance specifications are provided by the component manufacturers. Performance specifications represent the highest specification of all HP's component manufacturers' typical level specifications for performance and actual performance may vary either higher or lower.

### ZR30w Model

**Table B-1 ZR30w Specifications**

Display	75.4 cm wide screen	29.7 inches wide screen
Type	TFT LCD	
Viewable Image Size	75.4 cm diagonal	29.7-inch diagonal
Tilt	-5° to 35°	
Swivel	-45° to 45°	
Maximum Weight (Unpacked)	13 kg	28.6 lbs.
Dimensions (include base)		
Height (highest position)	58.9 cm	23.19 inches
Height (lowest position)	48.9 cm	19.25 inches
Depth	27.6 cm	10.87 inches
Width	69.4 cm	27.32 inches
Maximum Graphic Resolution	2560 x 1600 (60 Hz) digital input	
Optimum Graphic Resolution	2560 x 1600 (60 Hz) digital input	
Safe Mode	1280 x 800	
Dot Pitch	0.25 (H) x 0.25 (W) mm	
Pixels Per Inch	101 PPI	
Horizontal Frequency	100 kHz	
Vertical Refresh Rate	60 Hz	
Environmental Requirements Temperature		
Operating Temperature	5 to 35° C	41 to 95° F
Storage Temperature	-20 to 60° C	-4 to 140° F
Relative Humidity	10 to 80%	

**Table B-1 ZR30w Specifications (continued)**

Power Source	100 – 240 VAC, 50/60 Hz	
Altitude:		
Operating	0 to 5000 m	0 to 16,400 feet
Storage	0 to 12192 m	0 to 40,000 feet
Measured Power Consumption:		
Full Power	<185 watts	
Typical Settings	<130 watts	
Sleep	<2 watts	
Bezel Switch Off	<1 watt	
Input Terminal	One DVI connector with cable included; one DisplayPort connector with cable included	

## Energy Saver Feature

When the monitor is in its normal operating mode, the monitor uses less than 130 watts and the Power light is blue.

The monitor also supports a reduced power state. The reduced power state will be entered into if the monitor detects the absence of either the horizontal sync signal and/or the vertical sync signal. Upon detecting the absence of these signals, the monitor screen is blanked, the backlight is turned off, and the power light is turned amber. When the monitor is in the reduced power state, the monitor will utilize less than 2 watts of power. There is a brief warm up period before the monitor will return to its normal operating mode.

Refer to the computer manual for instructions on setting energy saver features (sometimes called power management features).

 **NOTE:** The above power saver feature only works when connected to computers that have energy saver features.

---

# C Agency Regulatory Notices

## Federal Communications Commission Notice

This equipment has been tested and found to comply with the limits for a Class B digital device, pursuant to Part 15 of the FCC Rules. These limits are designed to provide reasonable protection against harmful interference in a residential installation. This equipment generates, uses, and can radiate radio frequency energy and, if not installed and used in accordance with the instructions, may cause harmful interference to radio communications. However, there is no guarantee that interference will not occur in a particular installation. If this equipment does cause harmful interference to radio or television reception, which can be determined by turning the equipment off and on, the user is encouraged to try to correct the interference by one or more of the following measures:

- Reorient or relocate the receiving antenna.
- Increase the separation between the equipment and the receiver.
- Connect the equipment into an outlet on a circuit different from that to which the receiver is connected.
- Consult the dealer or an experienced radio or television technician for help.

## Modifications

The FCC requires the user to be notified that any changes or modifications made to this device that are not expressly approved by Hewlett Packard Company may void the user's authority to operate the equipment.

## Cables

Connections to this device must be made with shielded cables with metallic RFI/EMI connector hoods to maintain compliance with FCC Rules and Regulations.

## Declaration of Conformity for Products Marked with the FCC Logo (United States Only)

This device complies with Part 15 of the FCC Rules. Operation is subject to the following two conditions:

1. This device may not cause harmful interference.
2. This device must accept any interference received, including interference that may cause undesired operation.

For questions regarding the product, contact:

Hewlett Packard Company  
P. O. Box 692000, Mail Stop 530113  
Houston, Texas 77269-2000  
Or, call 1-800-HP-INVENT (1-800 474-6836)

For questions regarding this FCC declaration, contact:

Hewlett Packard Company  
P. O. Box 692000, Mail Stop 510101  
Houston, Texas 77269-2000  
Or, call (281) 514-3333

To identify this product, refer to the Part, Series, or Model number found on the product.

## Canadian Notice

This Class B digital apparatus meets all requirements of the Canadian Interference-Causing Equipment Regulations.

## Avis Canadien

Cet appareil numérique de la classe B respecte toutes les exigences du Règlement sur le matériel brouilleur du Canada.

## European Union Regulatory Notice

This product complies with the following EU Directives:

- Low Voltage Directive 2006/95/EC
- EMC Directive 2004/108/EC

Compliance with these directives implies conformity to applicable harmonized European standards (European Norms) which are listed on the EU Declaration of Conformity issued by Hewlett-Packard for this product or product family.

This compliance is indicated by the following conformity marking placed on the product:

---

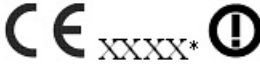
 <small>This marking is valid for non-Telecom products and EU harmonized Telecom products (e.g. Bluetooth).</small>	 <small>This marking is valid for EU non-harmonized Telecom products. *Notified body number (used only if applicable - refer to the product label).</small>
<hr/> <p>This marking is valid for non-Telecom products and EU harmonized Telecom products (e.g. Bluetooth)</p>	<hr/> <p>This marking is valid for EU non-harmonized Telecom products.  *Notified body number (used only if applicable — refer to the product label).</p>

---

Hewlett-Packard GmbH, HQ-TRE, Herrenberger Strasse 140, 71034 Boeblingen, Germany

The official EU CE declaration of conformity for this device may be found at <http://www.hp.com/go/certificates>.

## German Ergonomics Notice

HP products which bear the “GS” approval mark, when forming part of a system comprising HP brand computers, keyboards and monitors that bear the “GS” approval mark, meet the applicable ergonomic requirements. The installation guides included with the products provide configuration information.

## Japanese Notice

この装置は、クラスB情報技術装置です。この装置は、家庭環境で使用することを目的としていますが、この装置がラジオやテレビジョン受信機に近接して使用されると、受信障害を引き起こすことがあります。取扱説明書に従って正しい取り扱いをして下さい。

VCCI-B

## Korean Notice

B급 기기  
(가정용 방송통신기기)

이 기기는 가정용(B급)으로 전자파적합등록을 한 기기로서 주로 가정에서 사용하는 것을 목적으로 하며, 모든 지역에서 사용할 수 있습니다.

## Power Cord Set Requirements

The monitor power supply is provided with Automatic Line Switching (ALS). This feature allows the monitor to operate on input voltages between 100–120V or 200–240V.

The power cord set (flexible cord or wall plug) received with the monitor meets the requirements for use in the country where you purchased the equipment.

If you need to obtain a power cord for a different country, you should purchase a power cord that is approved for use in that country.

The power cord must be rated for the product and for the voltage and current marked on the product's electrical ratings label. The voltage and current rating of the cord should be greater than the voltage and current rating marked on the product. In addition, the cross-sectional area of the wire must be a minimum of 0.75 mm<sup>2</sup> or 18 AWG, and the length of the cord must be between 6 feet (1.8 m) and 12 feet (3.6 m). If you have questions about the type of power cord to use, contact an authorized HP service provider.

A power cord should be routed so that it is not likely to be walked on or pinched by items placed upon it or against it. Particular attention should be paid to the plug, electrical outlet, and the point where the cord exits from the product.

## Japanese Power Cord Requirements

For use in Japan, use only the power cord received with this product.

△ **CAUTION:** Do not use the power cord received with this product on any other products.

## Product Environmental Notices

### Materials Disposal

This HP product contains mercury in the fluorescent lamp in the display LCD that might require special handling at end-of-life.

Disposal of this material can be regulated because of environmental considerations. For disposal or recycling information, contact the local authorities or the Electronic Industries Alliance (EIA) <http://www.eiae.org>.

### Disposal of Waste Equipment by Users in Private Household in the European Union



This symbol on the product or on its packaging indicates that this product must not be disposed of with your household waste. Instead, it is your responsibility to dispose of your waste equipment by handing it over to a designated collection point for the recycling or waste electrical and electronic equipment. The separate collection and recycling of your waste equipment at the time of disposal will help to conserve natural resources and ensure that it is recycled in a manner that protects human health and the environment. For more information about where you can drop off your waste equipment for recycling, please contact the local city office, the household waste disposal service or the shop where you purchased the product.

### HP Recycling Program

HP encourages customers to recycle used electronic hardware, HP original print cartridges, and rechargeable batteries. For more information about recycling programs, go to <http://www.hp.com/recycle>.

### Chemical Substances

HP is committed to providing our customers with information about the chemical substances in our products as needed to comply with legal requirements such as REACH (Regulation EC No 1907/2006 of the European Parliament and Council). A chemical information report for this product can be found at <http://www.hp.com/go/reach>.

### Restriction of Hazardous Substances (RoHS)

A Japanese regulatory requirement, defined by specification JIS C 0950, 2005, mandates that manufacturers provide Material Content Declarations for certain categories of electronic products offered for sale after July 1, 2006. To view the JIS C 0950 material declaration for this product, visit <http://www.hp.com/go/jisc0950>.



2008年、日本における製品含有表示方法、JISC0950が公示されました。製造事業者は、2006年7月1日以降に販売される電気・電子機器の特定化学物質の含有につきまして情報提供を義務付けられました。製品の部材表示につきましては、www.hp.com/go/jisc0950を参照してください。

## 有毒有害物质/元素名称及含量表

### 根据中国 《电子信息产品污染控制管理办法》

#### 液晶显示器

部件名称	有毒有害物质和元素					
	铅 (Pb)	汞 (Hg)	镉 (Cd)	六价铬 (Cr(VI))	多溴联苯 (PBB)	多溴二苯醚 (PBDE)
液晶显示器显示面板	X	X	○	○	○	○
机箱/其它	X	○	○	○	○	○

#### CRT 显示器

部件名称	有毒有害物质和元素					
	铅 (Pb)	汞 (Hg)	镉 (Cd)	六价铬 (Cr(VI))	多溴联苯 (PBB)	多溴二苯醚 (PBDE)
阴极射线管	X	○	○	○	○	○
机箱/其它	X	○	○	○	○	○

O: 表示该有毒或有害物质在该部件所有均质材料中的含量均在 SJ/T11363-2006 标准规定的限量要求以下。

X: 表示该有毒或有害物质至少在该部件所用的某一均质材料中的含量超出 SJ/T11363-2006 标准规定的限量要求。

表中标有“X”的所有部件都符合欧盟 RoHS 法规 — “欧洲议会和欧盟理事会 2003 年 1 月 27 日关于电子电器设备中限制使用某些有害物质的 2002/95/EC 号指令”。

注：环保使用期限的参考标识取决于产品正常工作的温度和湿度等条件。

## Turkey EEE Regulation

In Conformity with the EEE Regulation

EEE Yönetmeliğine Uygundur

---

## D LCD Monitor Quality and Pixel Policy

The TFT monitor uses high-precision technology, manufactured according to HP standards, to guarantee trouble-free performance. Nevertheless, the display may have cosmetic imperfections that appear as small bright or dark spots. This is common to all LCD displays used in products supplied by all vendors and is not specific to the HP LCD. These imperfections are caused by one or more defective pixels or sub-pixels.

- A pixel consists of one red, one green, and one blue sub-pixel.
- A defective whole pixel is always turned on (a bright spot on a dark background), or it is always off (a dark spot on a bright background). The first is the more visible of the two.
- A defective sub-pixel (dot defect) is less visible than a defective whole pixel and is small and only visible on a specific background.

To locate defective pixels, the monitor should be viewed under normal operating conditions, in normal operating mode at a supported resolution and refresh rate, from a distance of approximately 50 cm (20 in).

HP expects that, over time, the industry will continue to improve its ability to produce LCDs with fewer cosmetic imperfections and HP will adjust guidelines as improvements are made.